



## TL410 family 4K Resolution Day/Night lenses up to 1/1.7" sensors

- ✓ **Ultra high resolution for 4K cameras**, up to 12.4 megapixel
- ✓ Available in DC **auto-iris**, **P-iris**, and **manual iris** versions
- ✓ **Fully motorized versions**, or combinations with zoom, focus, iris, IR cut, limit switch; non-motorized versions also available
- ✓ IR corrected for true **Day/Night** cameras
- ✓ **Compact design** to fit into domes as small as 4" mini-dome size
- ✓ **CS-mount** and smooth **D25 board mount** options, as well as **C-mount**
- ✓ Used for sensor sizes 1/2.5", 1/2.3", 1/2", 1/1.8", and **up to 1/1.7"** (Sony IMX178, Sony IMX226 for example)

### SL/TL410 lens family specifications

Focal length	4-10mm
Image circle	Ø9.4mm
Resolution	12.4 megapixel
F/#	F/1.4 @ 4mm – F/2.4 @ 10mm to close
Focus Range	0.5m to infinity
IR Correction	Day/Night
Lens length	< 64mm TTL
Back focal length	BFL 8.4mm (in air)
CRA	< 7°
Distortion	< 61% at 4mm, < 8% at 10mm
Relative illumination	>45%
Lens transmission	>80%
Weight	69-78g (depending on version)
Operating temperature	-20C to 60C (<70% humidity, non-condensing)
Storage temperature	-30C to 70C (<90% humidity, non-condensing)

### Field of view for sensor sizes

Sensor size	1/1.7"	1/1.8"	1/1.8" 4K*	1/2"	1/2.3"	1/2.5"
Horizontal	112° - 44°	110° - 43°	110° - 43°	93° - 37°	90° - 36°	83° - 33°
Vertical	81° - 33°	71° - 29°	52° - 21°	68° - 28°	67° - 27°	60° - 25°
Diagonal	149° - 55°	139° - 52°	126° - 48°	120° - 46°	117° - 45°	106° - 42°

\*4K format = 4000 x 2000 pixels

## Lens designation

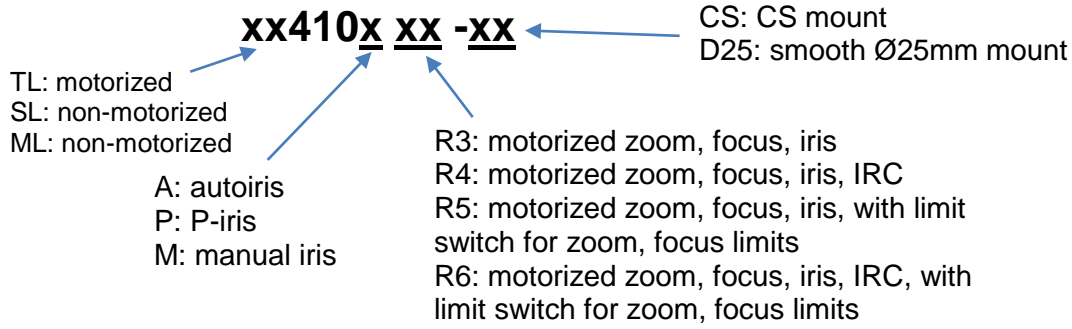

**Production versions:** (call for other versions)

SL410M (manual lens, manual iris, CS mount)  
 SL410A (manual lens, DC autoiris, CS mount)  
 SL410P (manual lens, P-iris, CS mount)  
 ML410M (manual lens, manual iris, C mount)  
 TL410A R6-CS (fully motorized, DC autoiris lens)  
 TL410P R6-CS (fully motorized, P-iris lens)  
 TL410P R6-25 (fully motorized, P-iris, D25 mount)

Other versions are available by special request and may

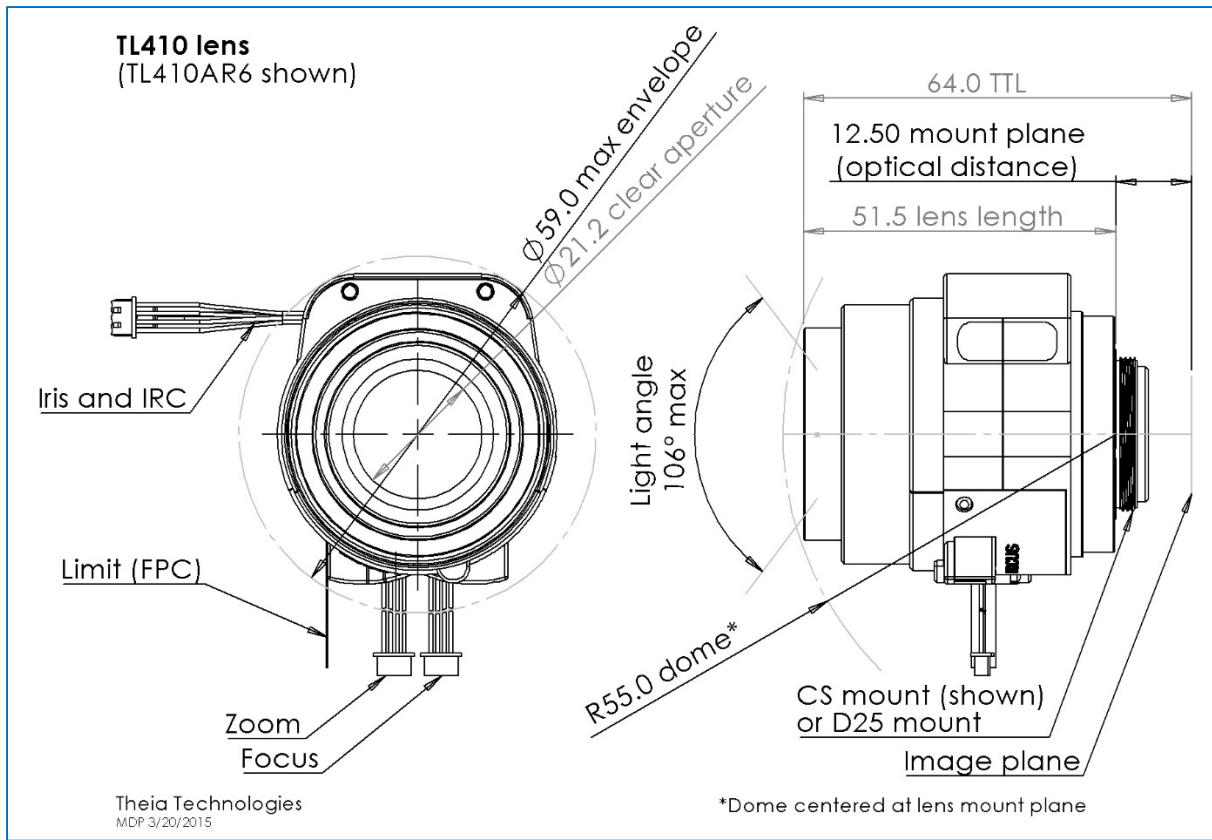

Drawings of several of the potential versions of the TL410 family.

Fully motorized (TL410 -AR6, -PR6)

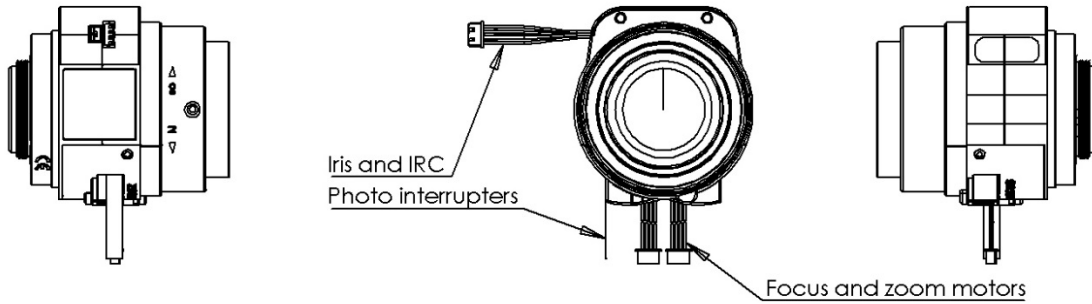

Autoiris/ P-iris (SL410A, SL410P)

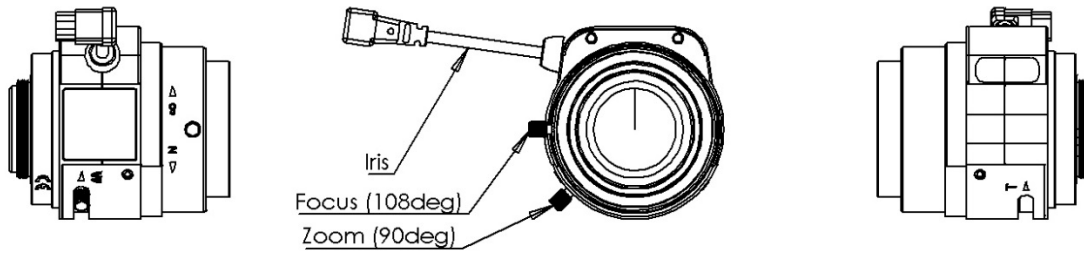

Manual version (SL410M)

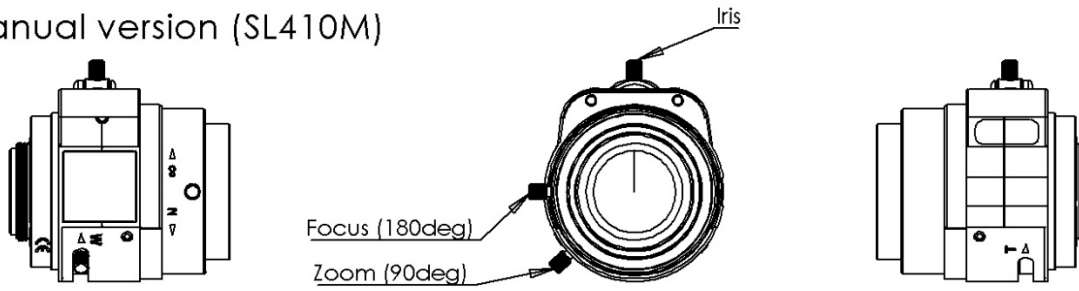

Autoiris/ P-iris, C-mount (ML410A, ML410P)

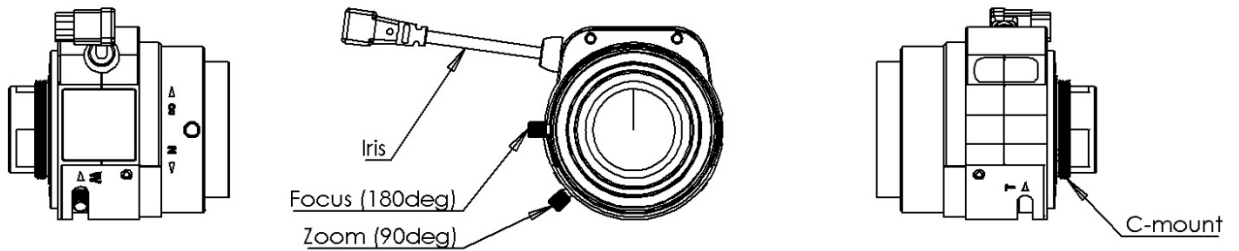

### Zoom/Focus motor specifications

Drive	Stepper motor 2 phase bipolar drive			
Operation voltage	3.3V (operating range 2.6~4.8V)			
Maximum continuous operation time (seconds) for operation voltage and ambient temperature*		3.3V	4.0V	4.8V
	20C	60s	12s	6s
	40C	35s	9s	5s
	60C	20s	6s	4s
Coil resistance	28.5Ω (±7%)			
Gear ratio	1:2025			
Zoom speed	4.1 sec (@1000pps)			
Zoom cam rotation	85°			
Focus speed	8.6 sec (@1000pps)			
Focus cam rotation	75°			
Focus/zoom connectors	Housing: Molex 51021-0800 Terminal: Molex 50058-8000			
Cable length	150mm			

Zoom: Wide -> Tele				
Focus: Near -> ∞				
Step	A+	A-	B+	B-
0	H	L	H	L
1	L	H	H	L
2	L	H	L	H
3	H	L	L	H

Pin	Color	Function	Motor
1	Brown	A+	Focus
2	Red	A-	Focus
3	Yellow	B+	Focus
4	Gray/Orange	B-	Focus
5	Brown	A+	Zoom
6	Red	A-	Zoom
7	Gray/Orange	B+	Zoom
8	Yellow	B-	Zoom

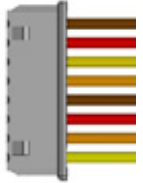

\*Do not let motor temperature exceed 115°C

### Zoom/Focus motor map for focus at infinity

Focal length	Note	Zoom ring rotation	Zoom motor step number	Focus ring rotation	Focus motor step number
[mm]		[deg]	[#]	[deg]	[#]
	Mech. stop	0	0	191.22	9118
4.15	Wide zoom end	0	0	180.00	8583
4.96		12.00	572	120.00	5722
5.77		24.00	1144	83.44	3979
6.58		36.00	1717	57.59	2746
7.39		48.00	2289	24.83	1184
8.19		60.00	2861	5.70	272
9.00		72.00	3433	-1.87	-89
9.70	PI trigger (zoom)	82.50	3934	-1.25	-60
9.90	Tele zoom end	85.42	4073	0.00	0
	PI trigger (focus)			2.50	119
	Mech. stop	85.42	4073	-12.22	-583

\*PI: photo interrupter trigger point for applicable models TL410A R5, TL410P R5, TL410A R6, TL410P R6

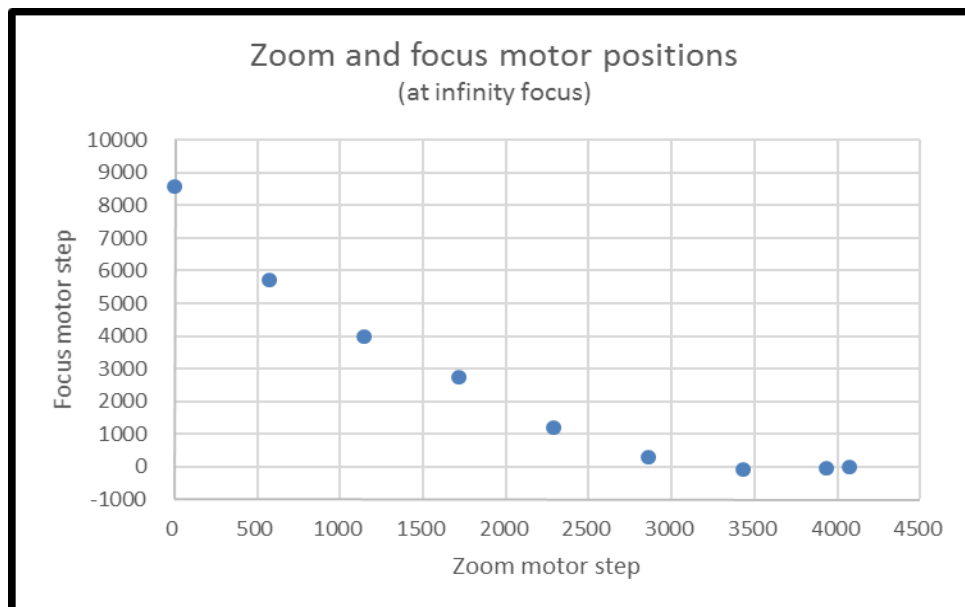

## DC autoiris motor specifications

Applicable models: SL410A, TL410Axx

Drive	DC
Operation voltage	3V (2.5~5.0V)
Max current consumption	22mA
Drive coil resistance	190Ω
Damper coil resistance	855Ω

Connector type 1 (Molex)

Connector type	Housing: Molex 51021-0400 Terminal: Molex 50058-8000
Cable length	150mm

Pin	Color	Function
1	Brown	Control -
2	Red	Control +
3	Yellow	Drive +
4	Orange	Drive -

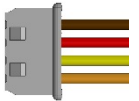

Connector type 2 (CCTV)

Connector type	Housing: EYC 221
Cable length	300mm

Pin	Function
1	Control -
2	Control +
3	Drive +
4	Drive -

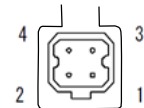

## P-iris motor specifications

Applicable models: SL410P, TL410Pxx

Drive	Stepper motor 2 phase bipolar drive
Operating voltage	4V (+/-1)
Number of steps	75
Basic step angle	18°
Maximum response freq.	1000pps
Coil resistance	30Ω (each phase)

P-iris: open->close				
Step	A+	A-	B+	B-
0	H	L	H	L
1	L	H	H	L
2	L	H	L	H
3	H	L	L	H

Connector type 1 (Molex)

Connector type	Housing: Molex 51021-0400 Terminal: Molex 50058-8000
Cable length	150mm

Pin	Color	Function
1	Brown	B+
2	Red	B-
3	Yellow	A+
4	Orange	A-

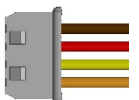

Connector type 2 (CCTV)

Connector type	Housing: EYC 221
Cable length	300mm

Pin	Function
1	B+
2	A+
3	A-
4	B-

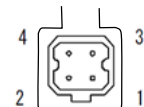

### P-iris motor map

Step	Aperture Size [mm <sup>2</sup> ]	F/#
1	65.0	1.43 (open)
5	65.0	1.43 (open)
10	65.0	1.43 (open)
15	65.0	1.43 (open)
19	65.0	1.43 (open)
20	63.4	1.50
25	54.0	1.63
30	44.9	1.78
35	36.0	1.98

Step	Aperture Size [mm <sup>2</sup> ]	F/#
40	27.7	2.26
45	20.0	2.65
50	13.2	3.26
55	7.5	4.34
60	3.1	6.71
65	0.8	12.86
70	0.1	46.06
72	0.0	Closed
75	0.0	Closed

### IR Cut specifications

Applicable models: TL410A R4, TL410P R4, TL410A R6, TL410P R6

Electrical specifications	
Drive	DC
Operating voltage	4V
Drive coil resistance	130Ω
Connector type	Housing: Molex 51021-0200 Terminal: Molex 50058-8000
Cable length	150mm
Optical specifications for IR filter (Day)	
Cut-on wavelength	405nm ±10nm
Visible transmission	430-610nm
Cut-off wavelength	650nm ±10nm
IR transmission	<5% max 700-1000nm <10% ave 1000-1100nm
Optical specifications for clear filter (Night)	
Visible transmission	400-1050nm

Mode	Pin 1	Pin 2
Day (IR filter)	L	H
Night (clear filter)	H	L
Wire color	Red	Black

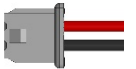

### Zoom/Focus limit switch

Applicable models: TL410A R5, TL410P R5, TL410A R6, TL410P R6

Type	Photo interrupter phototransistor
Part model	Sharp GP1S396HCPSF
Operating voltage	3.3V
Output level	>2.2V HIGH <0.6V LOW
Connector type	FPC cable
Board-side mating connector type (not supplied)	Molex 52746-0671 Molex 52745-0697 Molex 52559-0652
Cable length	150mm

Pin*	Function	Motor
1	Cathode	Zoom
2	Anode/Collector	Zoom
3	Emitter	Zoom
4	Cathode	Focus
5	Anode/Collector	Focus
6	Emitter	Focus



\*cable side pin designation matches Molex 52746-0697 connector

Recommended circuit for each photo interrupter

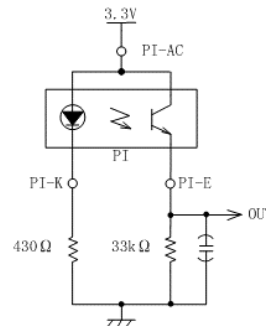

For more information contact  
Theia Technologies

info@TheiaTech.com  
[www.TheiaTech.com](http://www.TheiaTech.com)  
+1-503-570-3296

**Revisions**

<b>Version</b>	<b>Change</b>	<b>Reason</b>
160104	Changed IR cut pin-out	Changed to match industry standard
	Updated focus/zoom map	Due to changed focus cam design
160108	Added focus photo interrupter trigger point	Missing from spec
160112	Swapped 2 focus motor pins	Motor phases did not match stepper sequence direction
160113	Added motor energizing time maximums	Clarification to prevent focus/zoom motor overheating
	Updated temperature spec	Consistent with motor supplier specification
	Updated weight	Missing from spec
	Updated IR filter transmission specs	
160128	Swapped focus motor pin 3-4 functions	Not updated correctly when motor direction was reversed